

LHT EZ2 2001 HEAD, TAIL & LIGHT KIT

Instructions for EZGO TXT Models



BUGGIES
UNLIMITED

The Headlight Kit includes:

- (1) Complete Light Kit Harness
- (1) Wire Harness for brake lights (optional)
- (1) 20 amp light switch.
- (1) Left & Right hand headlight assemblies.
- (1) Left & Right hand tail light assemblies.
- (16) Mounting screws.
- (6) Tie Straps
- (1) Wiring instructions & templates



SET UP:

Reminder: Safety glasses should be worn at all times during the installation!

1) Disconnect the battery and/or battery pack before starting. **MAKE SURE YOU PLACE THE RUN/MAINTENANCE SWITCH IN THE TOW OR MAINTENANCE POSITION, BEFORE DISCONNECTING THE BATTERIES (DCS/PDS models only). FAILURE TO DO SO MAY DAMAGE THE ELECTRONIC SPEED CONTROLLER!**

2) Mark the headlight cut outs appropriately using the enclosed template. Take your time and ensure the template is lined up correctly for each side; use of a Dremel tool or our headlight/taillight cutter (TLS UNV 6024 sold separately) for cutting the holes. After the holes are cut, mount the light assemblies and double check they are in proper alignment prior to drilling the mounting screw holes (use 1/8" drill bit). Secure the assemblies with a Phillips head screw driver.

WIRE ROUTING:

1) Remove the seat assembly. From inside the battery compartment or engine compartment (on the driver's side), route the harness through and under the main frame along the cart's driver side. The part of the harness being used at this point is the light switch end and routing it towards the front of the cart to the dash and front headlights. The passenger side headlight is color coded with yellow, blue and black wires. The light harness will have matching colors for that side. The driver side headlight will have matching blue, green and black wires and the light harness will have matching colors for that side as well. Note: While routing the harness, make sure the harness wires do not interfere with any moving parts such as steering, brake, accelerator linkage and steering axle.

2) For ease of installation remove the cup holder assembly. Plug the front lights into the appropriate color coded connectors at this time, but do not tie off any loose wires of the harness until the rear installation is completed. Route the light switch to the dash and drill a 1/2" mounting hole for the switch (use a 31/64" drill bit for a tight fit).

3) Route the rear half of the harness under the rear of the body taking care the harness does not interfere with any moving parts or sharp objects. Ensure you are routing the proper color coded wires to the correct taillight assembly. Yellow, brown and black is the driver's side taillight assembly. Green, brown, and black is the passenger's side taillight assembly. Connect the color coded wires into the appropriate plug-in connectors. You are now ready to tie off all loose wiring. Use plastic tie straps to secure the harness starting at the front of the cart working your way back to the rear of the cart.

4) The final two connections will be the Black negative wire and Red positive wire to the battery pack (see diagram). There are two sizes of rings connectors in the kit. The rings with the 5/16" hole is for electric vehicles and the rings with the 3/8" hole are for gas vehicles. Again, ensure the wires are free of moving parts and sharp objects. Connect the cables back to the batteries and spray cote the terminals with Terminal Spray Protector (BT60512 sold separately). Wait 30 seconds (for DCS/PDS Carts only) after placing the Run/Maintenance switch back in the run position, before driving the cart.



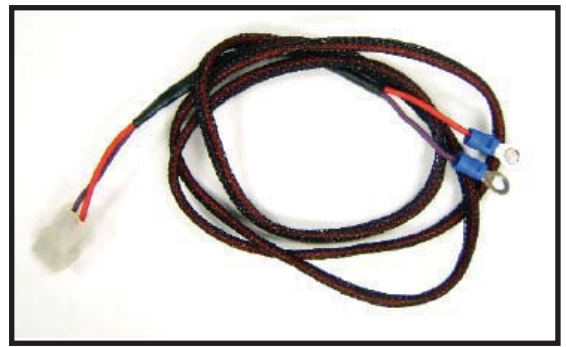
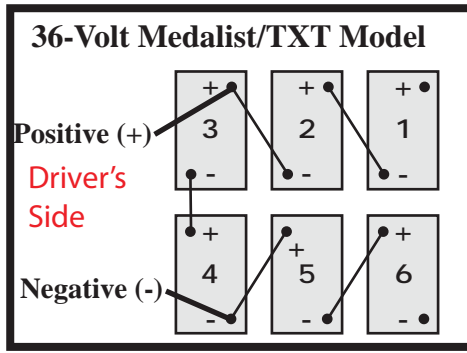
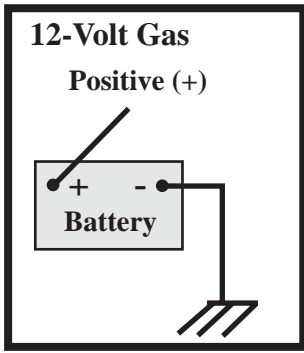

Main harness jumper leads (blue and orange) will be removed for turn signal system.

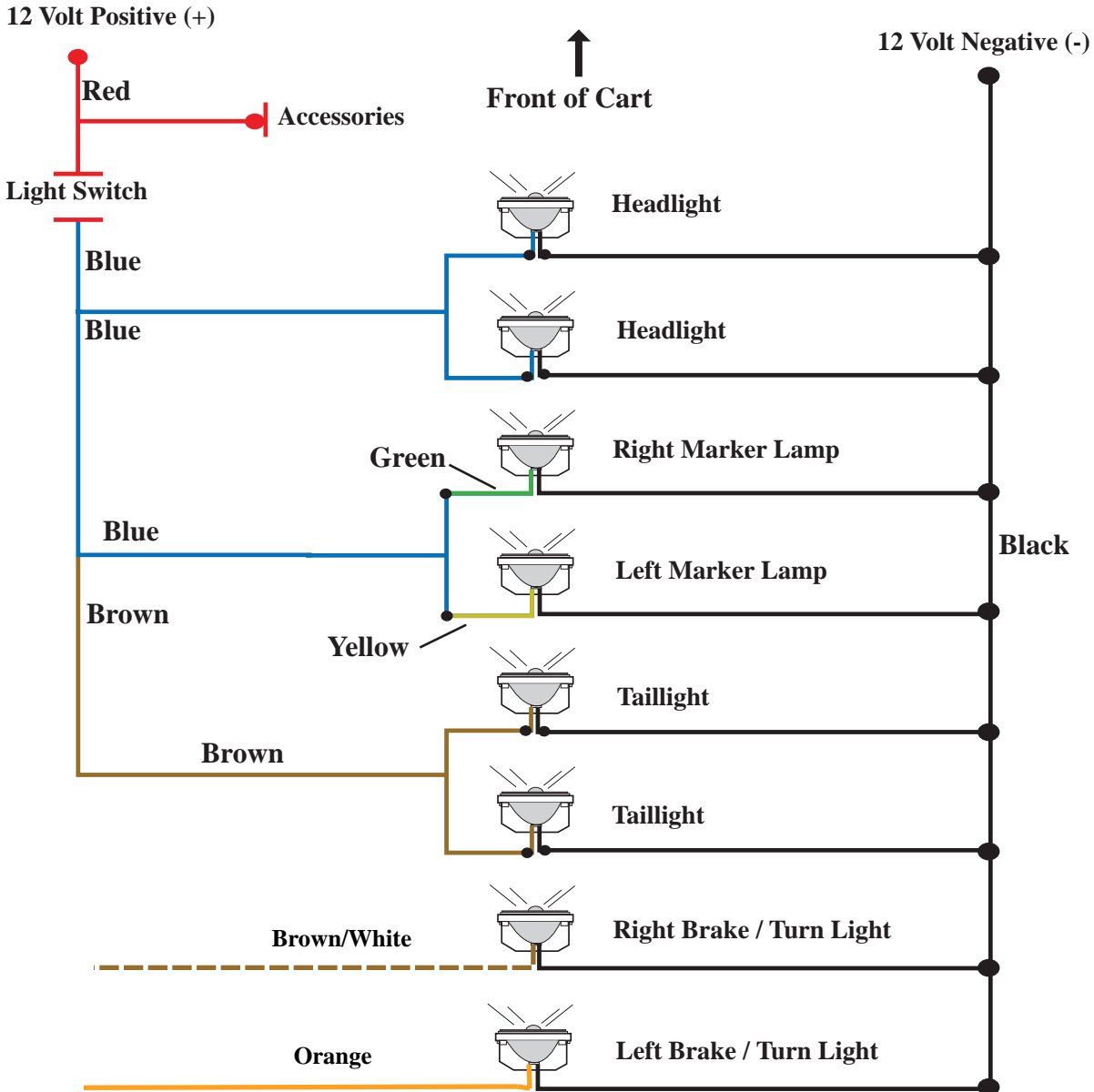

LHT EZ2 2001 HEADLIGHT Template for EZGO TXT Models

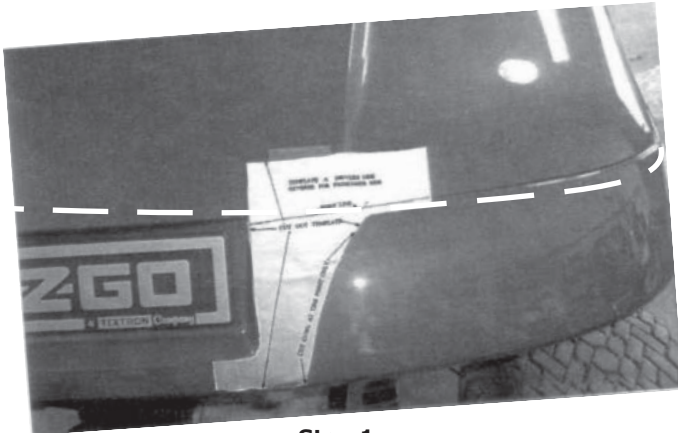

Step 1:
Align template "A" with body line - Front.

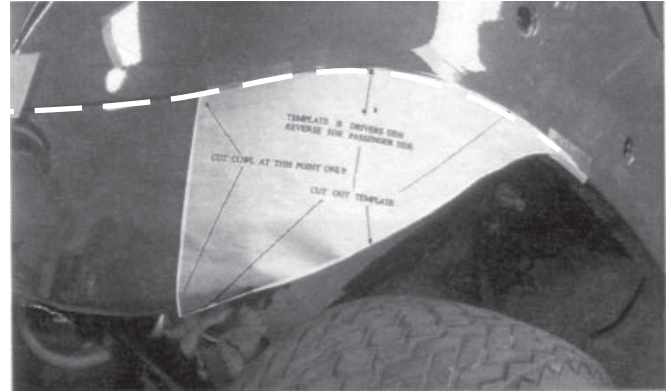

Step 2:
Align template "B" with body line - Side.

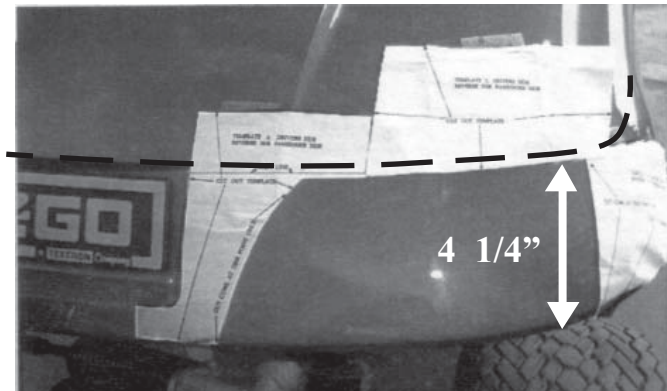

Step 3:
Align template "C" with template "A & B" and 1/8" below the body line as shown above. Be sure that the outside corner where "B" & "C" meet is not more than 4 1/4" above the bottom edge of the body.

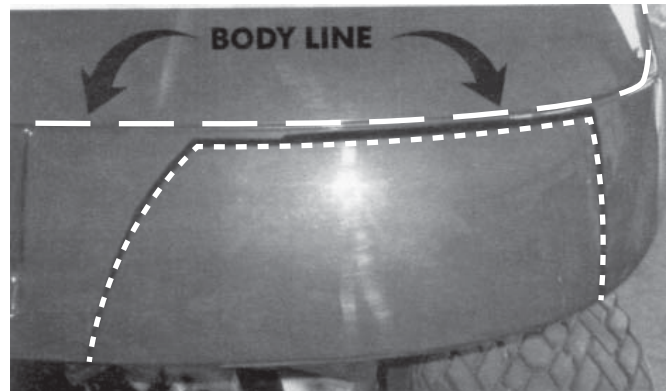

Step 4:
With all of the templates in place, take a black marker and outline (follow along) outer edge of the templates. CUT 1/8" BELOW THE BODY LINE. DO NOT CUT AT OR ABOVE BODY LINE.

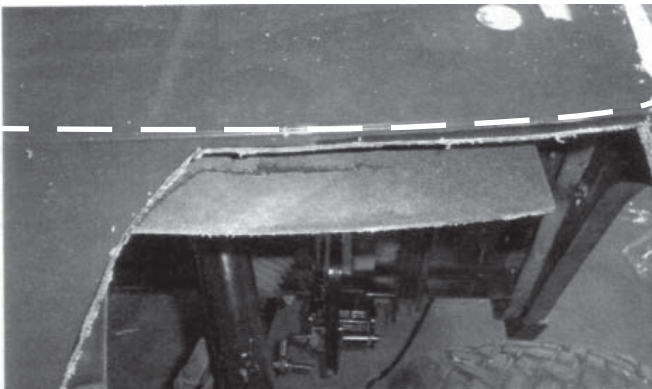

Step 5:
Once the cowl is cut away, follow along cowl edge and cut away dust cover.

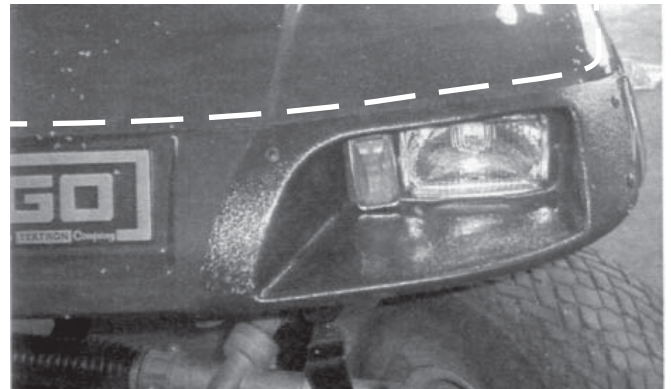

Step 6:
Place headlight assembly along body line and install screws.

Buggies Unlimited
1-888-444-9994
www.buggiesunlimited.com

©1997-2008 Buggies Unlimited. All Rights Reserved.

TEMPLATE



**CUT OUT TEMPLATE
ON DOTTED LINE**

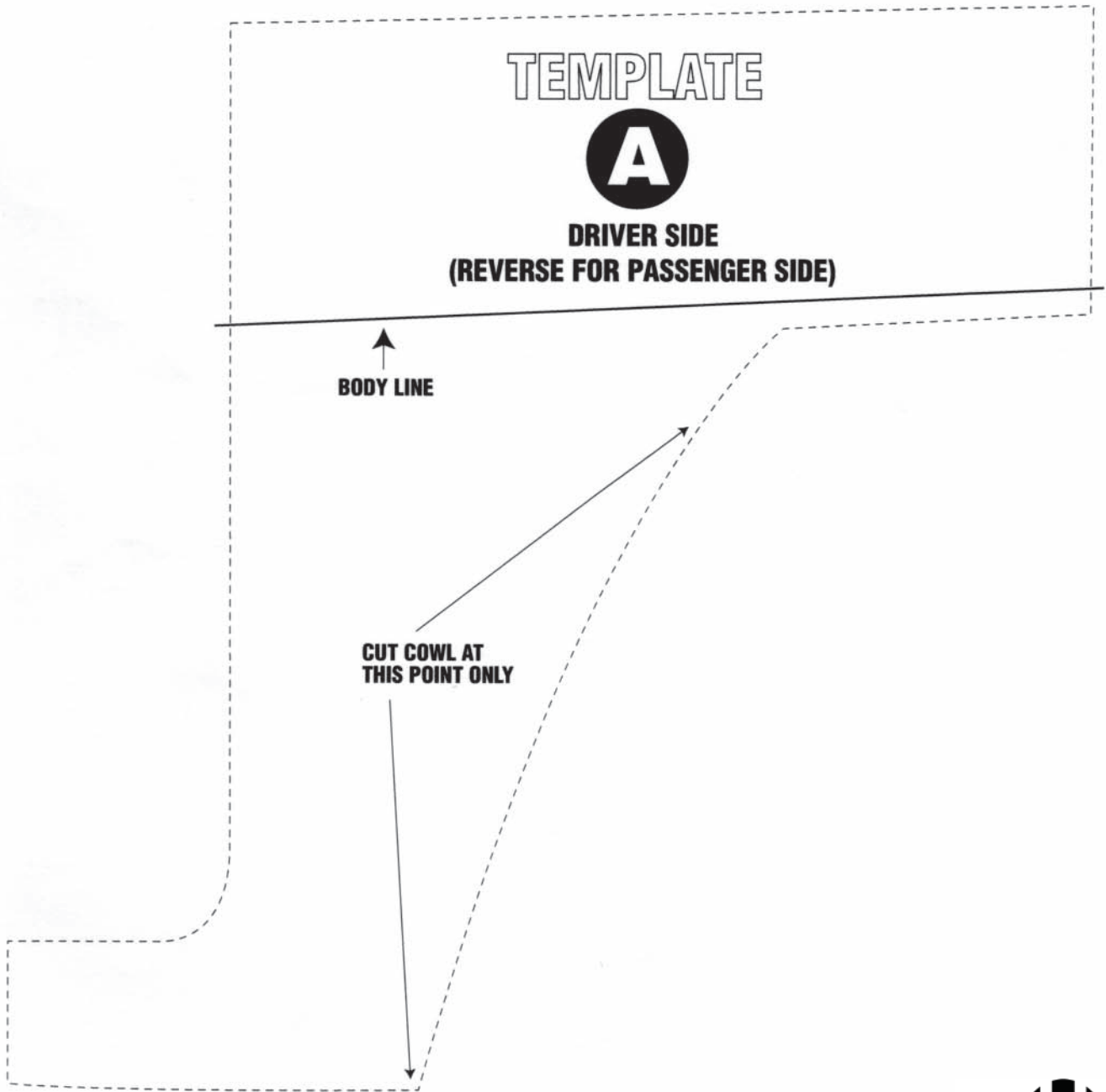

TEMPLATE



**CUT OUT TEMPLATE
ON DOTTED LINE**

TEMPLATE



**DRIVER SIDE
(REVERSE FOR PASSENGER SIDE)**

**CUT COWL AT
THIS POINT ONLY**

TEMPLATE



**CUT OUT TEMPLATE
ON DOTTED LINE**

TEMPLATE



**DRIVER SIDE
(REVERSE FOR PASSENGER SIDE)**



BUGGIES
UNLIMITED

Taillight Template
Place the template 2" over
from the bagwell side and
3 to 4" up from the bottom of
fender edge.



BUGGIES
UNLIMITED

*NOTE - In order for
the template to
line up, you must
print this sheet
at 100%. You
cannot scale
the printout
in any way.

Flip for left side.

Right

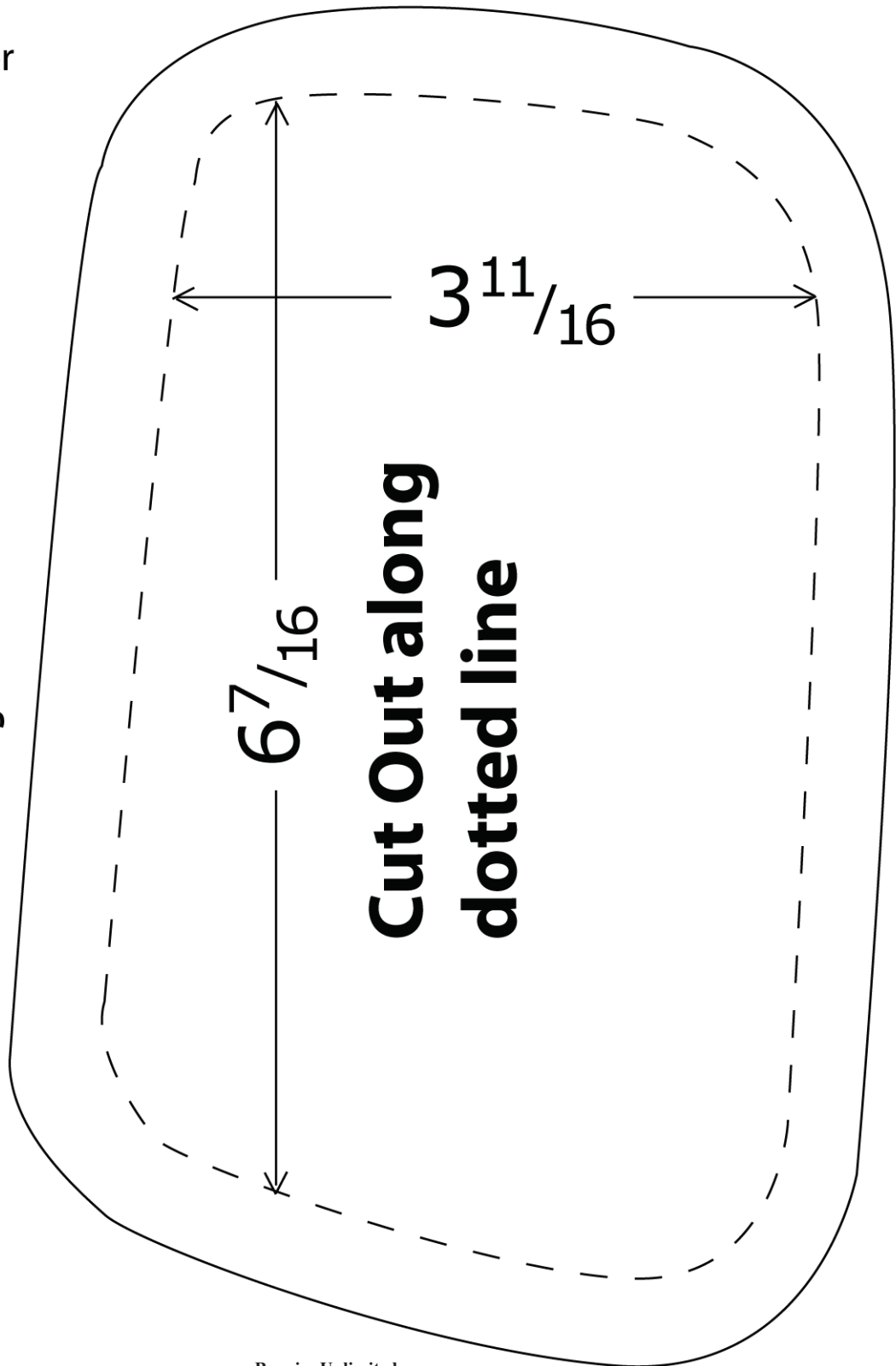

Buggies Unlimited
1-888-444-9994
www.buggiesunlimited.com

©1997-2008 Buggies Unlimited. All Rights Reserved.